

LEDSIGN-GW

Instant and Integrated Emergency Notification System



Miscellaneous

General

The OAX2-24V LED sign is a UL-listed display that integrates seamlessly with NOTIFIER fire alarm control panels, NOTI•FIRE•NET networks, and ONYXWorks®.

In the event of an emergency, the signs will automatically display emergency messages along with optional color changes that demand attention. These messages can be securely controlled from the NOTIFIER fire alarm control panel (FACP) through encrypted network protocols.

NOTIFIER LED SIGN GATEWAY

The LEDSIGN-GW Sign Interface is a key part of an Emergency Communications Response System (ECRS). The LEDSIGN-GW monitors events on one or more NFN network(s) and generates appropriate messages for up to ten OAX2-24V LED Displays. The NFN networks communicate with the LEDSIGN-GW Sign Interface through NFN Gateways over TCP/IP. Multiple sign gateways can communicate on the same NFN network if more than 10 signs are required.

Features

The LEDSIGN-GW:

- Controls up to 10 signs with message displays.
- Receives zone activations from up to 50 NFN Gateways.
- Stores 100 messages per LEDSIGN-GW.
- Contains predefined industry standard emergency messages that can be edited.
- Transmits custom or default messages according to defined priorities.
- Enables a predefined "System Normal" message to be displayed when there are no events.
- Overrides system-generated messages if it receives manually activated messages from the ONYXWorks Workstation. *ONYXWorks is not a required component but does add additional capabilities to the gateway.*

Compatible NFN Node Types and Networked Panels

LEDSIGN-GW is compatible with NOTI•FIRE•NET and High-Speed NOTI•FIRE•NET. An NFN gateway v3.16 (or later) must be used to interface with the NFN or fire alarm control panel.

Required Equipment

LEDSIGN-GW: UL-listed sign gateway. Interfaces with NOTI•FIRE•NET networks.

- Includes PNET-1 surge suppressor.
- Includes RJ45-RJ45 standard Ethernet network cable (PN 75585, provides gateway's TCP connection).

OAX2-24V: UL-listed LED sign. Sold separately.

- Includes PNET-1 surge suppressor.
- Customer to supply RJ45-RJ45 standard Ethernet network cable (provides PNET-1's internet/intranet connection) and standard Ethernet network cable (connects sign to gateway).



OAX2-24V

IP Requirements

An Internet or Intranet IP network connection is required. The Internet or Intranet IP network connection must meet the following requirements:

Parameter	Requirements
Ethernet Network Configuration	Private or Business LAN
TCP/IP Requirements	Static IP address required
Peer-to-Peer/Domain Support	Peer-to-Peer
Ethernet Connection	Standard 10/100Base-T Connection
Bandwidth Requirements	Minimal network traffic
DNS Support	No
Ports	22 (OAX2-24V sign)
Encryption	SSH (OAX2-24V sign)

LEDSIGN-GW Architecture

CAPABILITY

Parameter	Requirements
Maximum number of NFN Gateways per sign interface	50
Maximum number of sign gateways per NFN gateway	25*
Maximum number of signs per LEDSIGN-GW	10
Maximum number of OAX2-24V signs supported per NFN gateway	250
Time from event initiation to display on sign (typical)	8 seconds
Number of messages stored in LEDSIGN-GW	100
Maximum number of logic equations	50
* The NFN gateway supports up to 50 client connections. This number includes workstations and other clients that get data from the gateway.	

SYSTEM ARCHITECTURE AND DATA FLOW

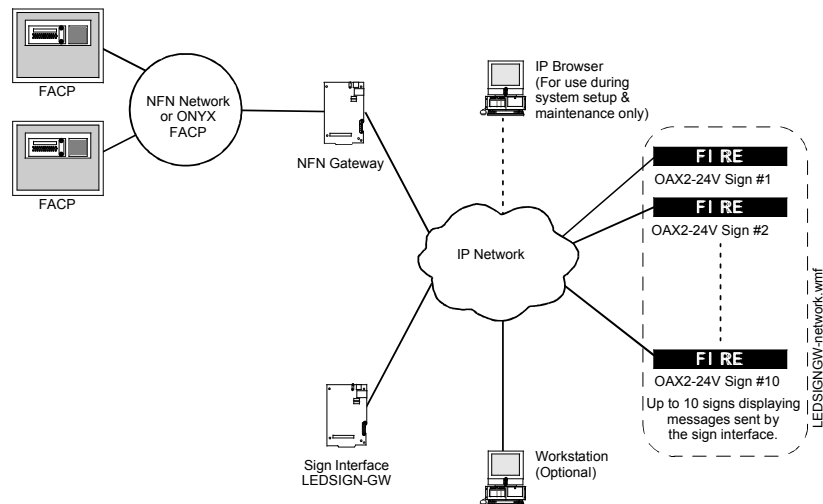

System Specifications

OAX2-24V SPECIFICATIONS

LED Colors: Three colors (red, yellow, green).

LED Size (Diameter): 0.2" (5 mm).

LED Spacing (Pitch): 0.3" (7.6 mm).

Character Set: Block profile (sans serif), upper/lower case.

Ethernet: TCP/IP connectivity.

Power: 24V DC, 0.5A with PoE backup, IEEE 802.3af compatible, 15.4 watts max using PoE switch.

Case Material: Black molded plastic over steel frame.

Mounting: Hardware for ceiling mount included. Optional wall, tilt wall or VESA mounts.

Weight: 6 lbs.

Dimensions: 30.9"L x 6.9"H x 2.3"D.

LEDSIGN-GW SPECIFICATIONS

The LEDSIGN-GW requires +24VDC @400mA nominal and supervised battery backup in accordance with local code requirements.

TEMPERATURE AND HUMIDITY RANGES

This system meets NFPA requirements for operation at 0 – 49°C/32 – 120°F and at a relative humidity 93% ± 2% RH (non-condensing) at 32°C ± 2°C (90°F ± 3°F). However, the useful life of the system's standby batteries and the electronic components may be adversely affected by extreme temperature ranges and humidity. Therefore, it is recommended that this system and its peripherals be installed in an environment with a normal room temperature of 15 – 27°C/60 – 80°F.

Compliance

The products in this document have been investigated to, and found to be in compliance with the following requirements from Underwriters Laboratories, Underwriters Laboratories Canada, and National Fire Protection Association:

- **NFPA 72** National Fire Alarm Code.

LED Sign OAX2-24V

- **UL 1638:** Visual Signaling Appliances - Private Mode Emergency and General Utility Signaling, 3rd Edition.
- **CSA C22.2 No. 205-M1983:** Signal Equipment.

ONYXWorks® Sign Gateway LEDSIGN-GW

- **UL 864:** Control Units for Fire Alarm Systems, 9th Edition.
- **UL 1076:** Proprietary Burglar Alarm Units and Systems.
- **CAN/ULC-S527-99:** Standard for Control Units for Fire Alarm Systems, 2nd Edition.
- **CAN/ULC-S559-04:** Equipment for Fire Signal Receiving Centres and Systems, 1st Edition.

Agency Listings and Approvals

The listings and approvals below apply to the basic product. In some cases, certain peripherals may not be listed by certain approval agencies, or listing may be in process. Consult factory for latest listing status.

- **UL/ULC:** S25007 (OAX2-24V), S5697 (LEDSIGN-GW).

NOTIFIER® and ONYXWorks are registered trademarks of Honeywell International Inc.

©2012 by Honeywell International Inc. All rights reserved. Unauthorized use of this document is strictly prohibited.



This document is not intended to be used for installation purposes.
We try to keep our product information up-to-date and accurate.
We cannot cover all specific applications or anticipate all requirements.
All specifications are subject to change without notice.

For more information, contact Notifier. Phone: (203) 484-7161, FAX: (203) 484-7118.
www.notifier.com