



# Drop-In Ceiling Speaker and Speaker Strobe for Life Safety Applications

*System Sensor Drop-In L-Series selectable-output speaker strobes and dual-voltage evacuation speakers enable faster trouble free installation.*



Speaker Strobe shown (as installed and close-up)

## Features

- Complete drop-in suspended ceiling speaker and speaker strobe assembly
- L-Series Platform, common speaker and low current strobe
- Field selectable candela settings on strobe units: 15, 30, 75, 95, 115, 150, and 177
- Automatic selection of 12- or 24-volt operation at 15 and 30 candela
- Rotary switch simplifies field selection of speaker voltage (25 and 70.7 Vrms) and power settings (¼, ½, 1 and 2 watts)
- Speakers offer high fidelity and high volume sound output
- Compatible with System Sensor synchronization protocol
- Electrical compatibility with existing L-Series, SpectrAlert®, and SpectrAlert Advance products
- UL Listed 2043, suitable for use in air-handling spaces
- Sized to use with standard drop-in ceiling systems 2 ft x 2 ft (61 cm x 61 cm opening)
- Includes seismic tie off or screw attachment points
- Speaker Strobe and Strobe models include a FIRE Decal. Additional Decals available as accessories.

## Agency Listings

### SIGNALING



S4048: SPCWL-TILE, SPCWLA-TILE,  
SPSCW-TILE, SPSCWA-TILE  
S5512: SCWL-TILE, SCWLA-TILE



3057493,  
3057383



7125-1653-0522  
(SCWL-TILE)  
7320-1653-0521  
(SPSCW-TILE, SPCWL-TILE)

**System Sensor L-Series Drop-In Ceiling speaker strobes, speakers and strobes** install faster than the traditional ceiling speaker or speaker strobe appliances. Neutral grill pattern makes this an excellent option for schools, office buildings, retail, restaurants, and hospital applications. Quickly upgrade your existing Horn Strobe application to a voice system or spec this for your next new construction project.

These devices also enable faster installations by providing quick wire nut connections, rotary switches to select voltage and power settings, and seven field-selectable candela settings for ceiling speaker strobes.

The low total harmonic distortion of the L-Series speaker offers high fidelity sound output while still offering high volume sound output for use in high ambient noise applications.

### L-Series makes installation easy

- Complete turn-key solution that eliminates the need for a separate back box, extension ring, and suspended ceiling support bracket.
- Less time working overhead which reduces installer fatigue
- No more wasting time routing wires in a crowded junction box to make space for the back of the speaker
- Perfect fit, the First Time, Every Time. No more adjusting support brackets to get a tight fit between the appliance and ceiling tile
- Simplified wiring process saves time and eliminates ground faults
- Fast learning curve for new installers or summer helpers supporting school retrofits.

# L-Series Speaker Strobe, Speaker, and Strobe Specifications

## Architect/Engineer Specifications

### General

L-Series Drop-In speaker and speaker strobes shall mount to a 2 ft x 2 ft (61 cm x 61 cm) suspended ceiling tile opening. The back box is contained within the speaker or speaker strobe assembly. The notification appliance circuit and amplifier wiring shall terminate to wires within the assembly. Also, L-Series speaker strobes, when used with the Sync•Circuit™ Module accessory, shall be powered from a non-coded notification appliance circuit output and shall operate on a nominal 12 or 24 volts. When used with the Sync•Circuit Module, 12-volt rated notification appliance circuit outputs shall operate between 8.5 and 17.5 volts; 24-volt rated notification appliance circuit outputs shall operate between 16.5 and 33 volts. Indoor L-Series products shall operate between 32°F and 120°F (0°C and 49°C) from a regulated DC, or full-wave rectified, unfiltered power supply. Speaker strobes shall have field-selectable candela settings including 15, 30, 75, 95, 115, 150, 177.

### Speaker

The speaker shall be a System Sensor L-Series model dual-voltage transformer speaker capable of operating at 25.0 or 70.7 nominal Vrms. It should be listed to UL 1480 (ULC in Canadian applications) and shall be approved for fire protective service. The speaker shall have a frequency range of 400 to 4,000 Hz and shall have an operating temperature between 32°F and 120°F (0°C and 49°C). The speaker shall have power taps and voltage that are selected by rotary switches.

### Speaker Strobe Combination

The speaker strobe shall be a System Sensor L-Series model listed to UL1480 and UL 1971 (ULC in Canadian applications) and be approved for fire protective signaling systems. The speaker shall be capable of operating at 25.0 or 70.7 nominal Vrms selected via rotary switch, and shall have a frequency range of 400 to 4,000 Hz. The speaker shall have power taps that are selected by rotary switch. The strobe shall comply with the NFPA 72 requirements for visible signaling appliances, flashing at 1 Hz over the strobe's entire operating voltage range. The strobe light shall consist of a xenon flash tube and associated lens/reflector system.

### Synchronization Module

The module shall be a System Sensor Sync•Circuit model MDL3 listed to UL 464 (ULC in Canadian applications) and shall be approved for fire protective service. The module shall synchronize SpectrAlert strobes at 1 Hz. The module shall mount to a 4<sup>11/16</sup> x 4<sup>11/16</sup> x 2<sup>1/8</sup>-inch (11.9 cm x 11.9 cm x 5.4 cm) back box. The module shall also control two Class B circuits or one Class A circuit. The module shall synchronize multiple zones. Daisy chaining two or more synchronization modules together will synchronize all the zones they control. The module shall not operate on a coded power supply.

## Physical Specifications

<b>Standard Operating Temperature</b>	32°F to 120°F (0°C to 49°C)		
<b>Humidity Range</b>	10 to 93% non-condensing		
<b>Dimensions</b>	<b>Length</b>	<b>Width</b>	<b>Depth</b>
SPCWL-TILE/SPCWLA-TILE Speaker	23.69 in. (602 cm)	23.69 in. (602 cm)	3.29" (84 mm)
SCWL-TILE/ SCWLA-TILE Strobe	23.69 in. (602 cm)	23.69 in. (602 cm)	3.29" (84 mm)
SPSCWL-TILE/SPSCWLA-TILE Speaker Strobe	23.69 in. (602 cm)	23.69 in. (602 cm)	3.29" (84 mm)

## Electrical Specifications

<b>Nominal Voltage (speakers)</b>	25 Volts or 70.7 Volts (nominal)
<b>Maximum Supervisory Voltage (speakers)</b>	50 VDC
<b>Strobe Flash Rate</b>	1 flash per second
<b>Nominal Voltage (strobes)</b>	Regulated 12 VDC or regulated 24 VDC/FWR <sup>1,2</sup>
<b>Operating Voltage Range (includes fire alarm panels with built in sync)</b>	8 to 17.5 V (12 V nominal) or 16 to 33 V (24 V nominal)
<b>Operating Voltage with MDL3 Sync Module</b>	8.5 to 17.5 V (12 V nominal) or 16.5 to 33 V (24 V nominal)
<b>Frequency Range (Speakers)</b>	400 to 4,000 Hz <sup>3</sup>
<b>Power</b>	¼, ½, 1, 2 watts

### Notes:

1. Full Wave Rectified (FWR) voltage is a non-regulated, time-varying power source that is used on some power supply and panel outputs.
2. Strobe products will operate at 12 V nominal only for 15 and 30 cd.
3. 520 Hz +/- 10% square wave tone capable with compatible fire alarm control panel.

## UL/ULC Current Draw and Sound Output Data

UL/ULC Max. Strobe Current Draw (mA RMS)				
Candela	8 to 17.5 Volts		16–33 Volts	
	DC		DC	FWR
15	87		41	60
30	153		63	86
75	NA		111	142
95	NA		134	164
115	NA		158	191
150	NA		189	228
177	NA		226	264

Ceiling-Mount Speaker Sound Output		
Setting	UL Reverberant (dBA @10 ft)	ULC Anechoic (dBA @10 ft)
¼ W	77	79
½ W	79	82
1 W	83	85
2 W	86	88

## Features

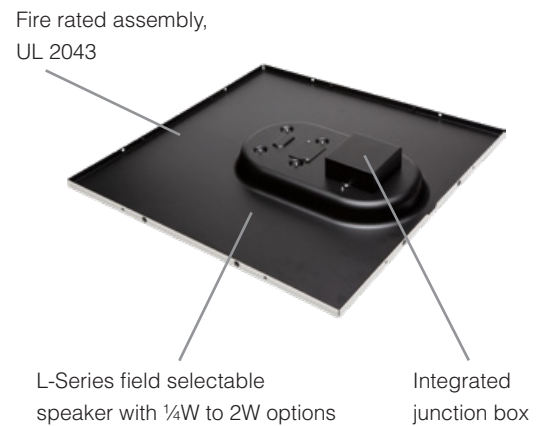
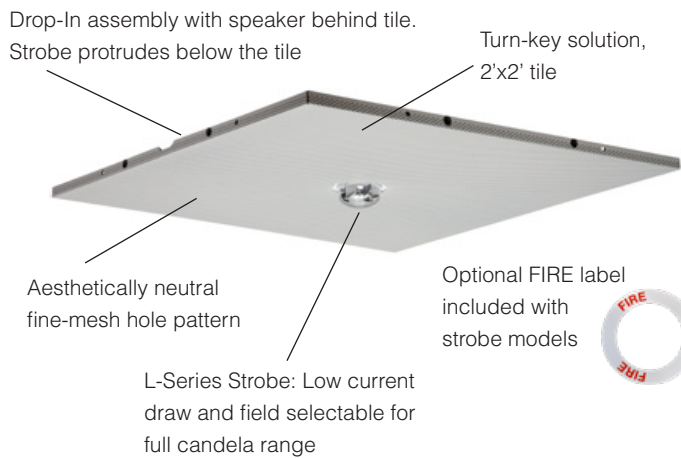



Front View of Speaker



Front View of Strobe



Front View of Speaker Strobe

## L-Series Ordering Information

Ceiling Mount		
Model Number	Marking	Description
SPCWL-TILE	PLAIN	Speaker Only, UL-listed
SPCWLA-TILE	PLAIN	Speaker Only, ULC-listed
SCWL-TILE	FIRE	Strobe Only, UL-listed
SCWLA-TILE	FIRE	Strobe Only, ULC-listed
SPSCWL-TILE	FIRE	Speaker Strobe, UL-listed
SPSCWLA-TILE	FIRE	Speaker Strobe, ULC-listed
Accessories		
DECAL-TILE-ALERT	ALERT	Labeling Kit, ALERT (pack of 10)
DECAL-TILE-E	FIRE	Labeling Kit, FIRE (pack of 10)
DECAL-TILE-FR	FIRE/FEU	Labeling Kit, FIRE/FEU (pack of 10)
DECAL-TILE-SPF	FUEGO	Labeling Kit, FUEGO (pack of 10)
LENS-AC2	na	Lens, Ceiling, Amber
LENS-BC2	na	Lens, Ceiling, Blue
LENS-GC2	na	Lens, Ceiling, Green
LENS-RC2	na	Lens, Ceiling, Red

System Sensor® and SpectrAlert® are registered trademarks and Sync•Circuit™ is a trademark of Honeywell International, Inc.



3825 Ohio Avenue • St. Charles, IL 60174  
 Phone: 800-SENSOR2 • Fax: 630-377-6495

©2021 System Sensor.  
 Product specifications subject to change without notice. Visit [systemsensor.com](http://systemsensor.com) for current product information, including the latest version of this data sheet.  
 AVDS908-02 • 02/01/2020